

SKY WEB II™

Fall Protection
Insulation Support System

Installation Instructions

SKY-WEB II™ DRAWING INDEX

DRAWING NUMBER	TITLE
1081340	GENERAL INFORMATION
1081341	PARTS IDENTIFICATION
1081342	INSTALLATION OR BLDG. STRUCT.
1081343	INSTALLATION SEQUENCE
1081344	MESH ATTACHMENT STARTING DETAIL
1081345	ENDWALL DETAILS
1081346	MESH TO MESH SPICE DETAILS
1081347	DETAILS AT PARAPET WALLS

WARNING
Workers must use additional fall protection while installing the SKY-WEB II SYSTEM.

WARNING
The SKY-WEB II SYSTEM must be installed exactly as shown on erection drawings. Improper installation could result in serious injury or death.

WARNING
The SKY-WEB II SYSTEM does not provide fall protection from heights greater than the plane of the roof.

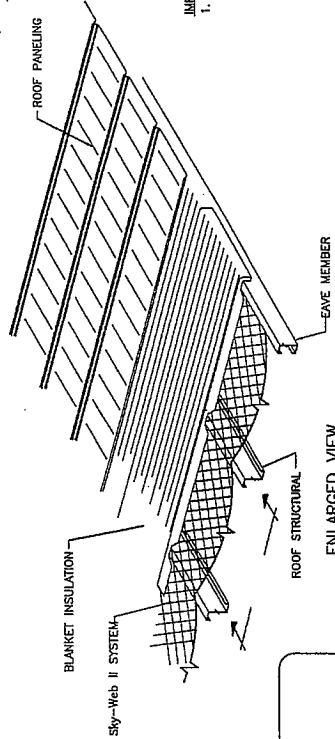
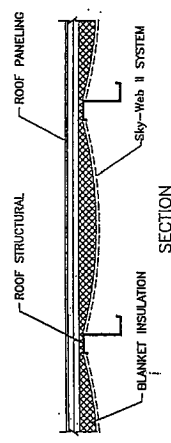

WARNING
After installation the SKY-WEB II SYSTEM protects only the leading edge of the roof surface. Fall protection must be used at the remaining perimeter of the roof.

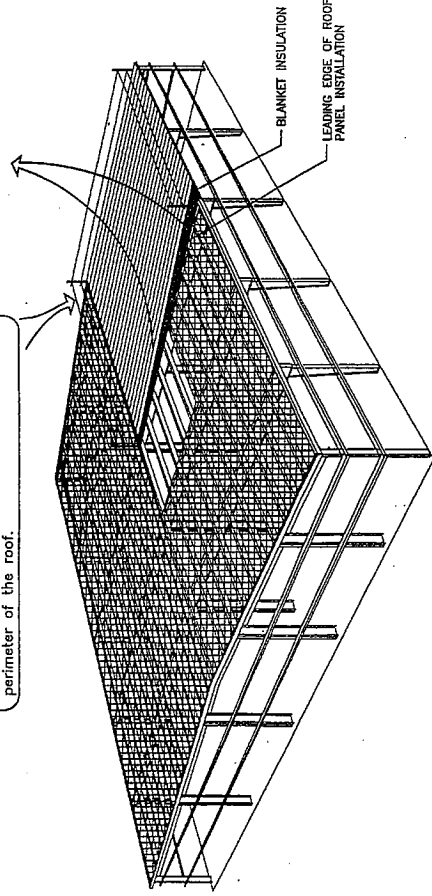

TYPICAL BUILDING PLAN

ALL BUILDING MATERIALS, PRIMARY AND SECONDARY STRUCTURALS AND ALL BRACING (WIND, FLANGE AND PURLIN) MUST BE ASSEMBLED AND THE ALL STRUCTURAL MEMBERS MUST BE INSTALLED BEFORE THE SKY-WEB II SYSTEM IS INSTALLED. THE EAVE MEMBER OR GATE MEMBERS MAY NEED TO BE SUPPORTED TO ELIMINATE DEFLECTION.

IMPORTANT SAFETY INFORMATION:

- SAFETY MUST BE A PRIME CONCERN THROUGHOUT THE ENTIRE CONSTRUCTION OF THE SKY-WEB II SYSTEM. ALL LOCAL, STATE AND FEDERAL SAFETY REGULATIONS MUST BE FOLLOWED AT ALL TIMES. THE ERECTION CONTRACTOR HAS THE ULTIMATE RESPONSIBILITY FOR THE SAFETY OF WORKERS AND MUST COMPLY WITH ALL APPLICABLE SAFETY REGULATIONS.
- THE SKY-WEB II SYSTEM DOES NOT PROVIDE FALL PROTECTION FOR WORKERS ON THE ROOF SURFACE. FALL PROTECTION DEVICES MUST BE USED AT ALL TIMES. THE ERECTION CONTRACTOR IS RESPONSIBLE FOR MAKING SURE THE APPROPRIATE DEVICE IS USED IN ACCORDANCE WITH ALL LOCAL, STATE AND OSHA REGULATIONS.
- ONLY THE LEADING EDGE OF THE ROOF SURFACE. DO NOT USE THE SKY-WEB II SYSTEM FOR ANY OTHER PURPOSE.
- THE SKY-WEB II SYSTEM MUST BE INSTALLED IN ACCORDANCE WITH THE INSTALLATION INSTRUCTIONS. IF THIS IS NOT POSSIBLE, CONTACT THE SUPPLIER FOR FURTHER INSTRUCTIONS BEFORE ANY FURTHER INSTALLATION IS ATTEMPTED.
- IF THE SKY-WEB II MESH IS DAMAGED, CONTACT THE SUPPLIER IMMEDIATELY. THE SKY-WEB II MESH IS NOT TO BE REPAIRED. OTHER FALL PROTECTION DEVICES MUST BE USED.
- THE SKY-WEB II SYSTEM IS NOT DESIGNED TO MEET THE CRITERIA FOR FALL PROTECTION SYSTEMS SET FORTH BY OSHA (29 CFR 1926) AND SHOULD NEVER BE USED AS SUCH.
- QUALITY ASSURANCE TESTING, WITNESSED BY AN INDEPENDENT CONSULTING FIRM, PROMISED VERIFICATION OF THE SKY-WEB II SYSTEM CAPABILITIES.
- SMALL HAND TOOLS AND FASTENERS MAY FALL THROUGH THE SKY-WEB II SYSTEM. ALL TOOLS AND FASTENERS MUST BE KEPT UNDERNEATH WHILE THE ROOF PANELS ARE BEING INSTALLED.
- WHEN A WORKER FALLS INTO THE SKY-WEB II MESH, THE MESH WILL PULL IN TOWARD HIM AND WILL STRETCH ELASTICALLY. WORKERS SHOULD BE AWARWARE THAT THEY WILL FALL INTO THE MESH AT A DISTANCE OF 4 FEET BELOW THE WORK LEVEL.
- RECOMMENDED RESCUE PROCEDURE: IF A FALLEN WORKER IS NOT INJURED HE MAY WALK OUT OF THE MESH BACK TO THE INSTALLED ROOF PANELS. IF A FALLEN WORKER IS INJURED, THE RESCUERS MUST FIRST REMOVE A FALLEN WORKER FROM THE MESH AND REACH THE FALLEN WORKER BY WALKING ON THE ROOF FRAMING. THE FALLEN WORKER SHOULD BE WITHIN EASY REACH OF THE RESCUERS. THE FALLEN WORKER NOT GET INTO THE MESH WITH THE ABOVE WORKER.
- THE SKY-WEB II SYSTEM IS NOT DESIGNED TO WITHSTAND A WIND AND SMOKE DEVELOPED INDEX OF LESS THAN 10 AS TESTED ACCORDING TO U.L. 723.

THIS PRINT SUBJECT TO CHANGE WITHOUT NOTICE. FOR BUILDING ERECTION ALWAYS USE THE PRINTS RECORDED WITH THE BUILDING PERMIT.

for Design & Fabrication

GENERAL INFORMATION

SKY-WEB II™

ALL BUILDINGS

DATE: 05/05/03
SCALE: 1/8"=1'-0"
DRAWING NUMBER: B 1081340-02

DATE: 05/05/03
SCALE: 1/8"=1'-0"
DRAWING NUMBER: B 1081340-02

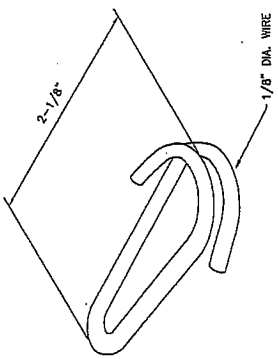

WIRE CLIP
PART NUMBER 650414

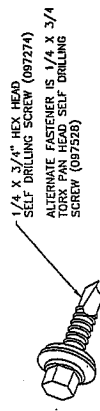

V-STRAP SELF DRILLING SCREW

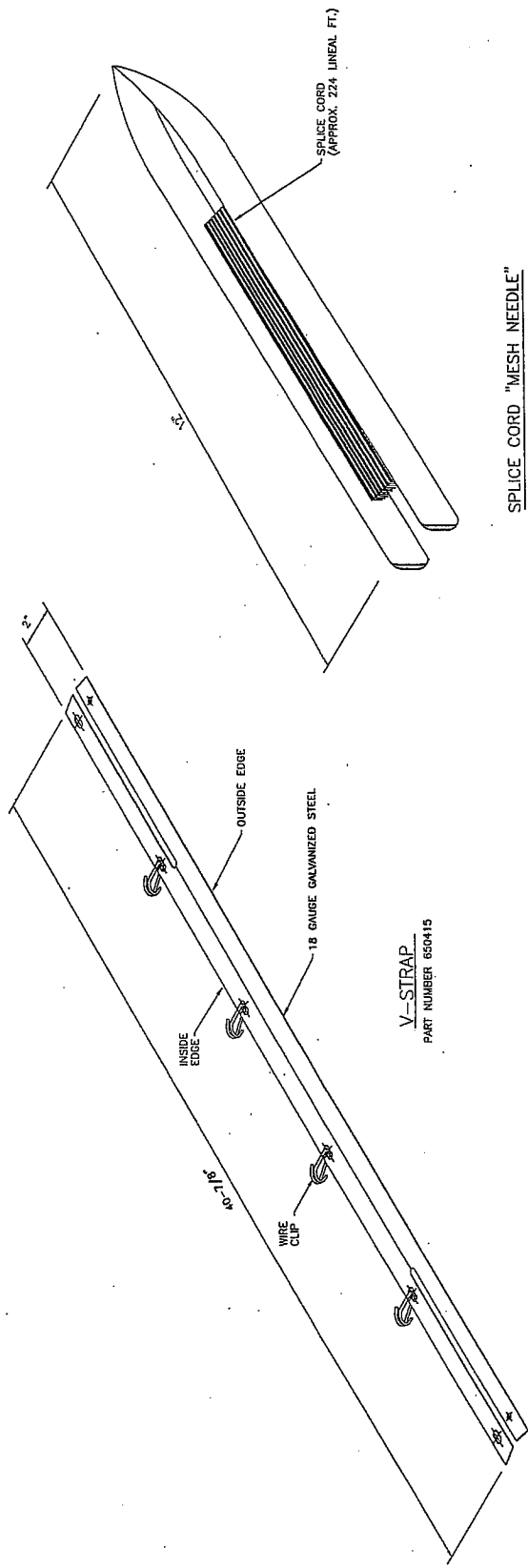

V-STRAP
PART NUMBER 650415

SPLICE CORD "MESH NEEDLE"

DATE	BY	CHKD	APP'D	DESCRIPTION
09/28/98	JMS	MJM		REVISED MESH NEEDLE
12/10/99	JMS	MJM		REVISED MESH NEEDLE
07/21/00	JMS	MJM		CHANGED MESH NEEDLE
08/17/03	JMS	MJM		CHANGED TO 1/8" DIA. WIRE CLIP
09/23/04	JMS	MJM		ADDED ALTERNATE FASTENER
09/22/05	JMS	MJM		REVISED FASTENER PART
	JMS	MJM		REVISED MESH NEEDLE

THIS PRINT SUBJECT TO CHANGE WITHOUT NOTICE.
FOR BUILDING ERECTION ALWAYS USE THE PRINTS
RECEIVED WITH THE BUILDING SHIPMENT.

for Division of Identification

ALL BUILDINGS

SKY-WEB II™

PARTS IDENTIFICATION

DATE: 09/28/98
DRAWN: JMS
CHECKED: MJM
GROUP: 01-019-01

REVISED NUMBER: B 1081341 05

01-019-01 B 1081341 05

CAUTION

Care must be used when pulling the SKY-WEB II SYSTEM over structurals to avoid snags, tears, or other damage.

WARNING

The SKY-WEB II SYSTEM must be installed exactly as shown on erection drawings. Improper installation could result in serious injury or death.

WARNING

The SKY-WEB II SYSTEM does not provide fall protection from heights greater than the plane of the roof.

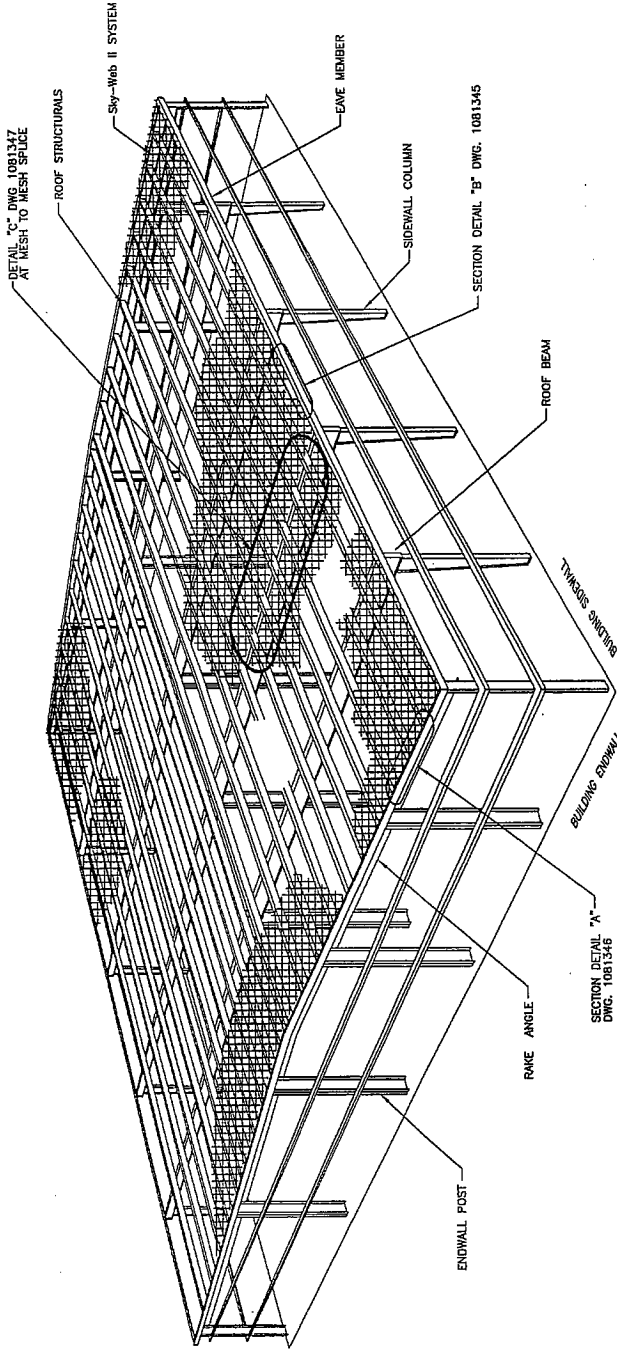

NOTES:

- ONE PIECE OF THE SKY-WEB II™ MESH MAY COVER ONE BAY OR TWO BAYS OF THE BUILDING LENGTH AND WILL EXTEND EAVE-TO-EAVE ACROSS THE BUILDING.
- MESH TO MESH SPICES WILL BE LOCATED OVER PRIMARY FRAMES. THERE IS NO OVERLAP OF THE MESH AT THE SPICE.
- MESH FOR END BAYS IS DIFFERENT THAN MESH FOR INTERIOR BAYS. THE MESH FOR INTERIOR BAYS IS IDENTIFIED BY THE USE OF ORANGE MARKED THREADS FOR IDENTIFICATION. THIS EDGE MUST BE LOCATED AT THE ENDWALL.
- THE SPACING OF THE WIRE CLIPS IS DESIGNED TO COORDINATE WITH THE SIZE OF THE MESH GRIDS. THEREFORE THE ATTACHMENT OF THE MESH TO THE WIRE CLIPS SHOULD BE EVEN AND UNIFORM AT THE SIDEWALL AND AT THE ENDWALL. A LINE OF KNOTS SHOULD RUN PARALLEL ALONG THE EAVE MEMBERS.

IT IS RECOMMENDED THAT THE SKY-WEB II SYSTEM BE INSTALLED OVER THE ENTIRE BUILDING BEFORE INSTALLING INSULATION AND ROOF PANELS. IF NECESSARY IT IS ACCEPTABLE TO INSTALL THE MESH OVER PART OF THE BUILDING IF THE FOLLOWING PROCEDURES ARE FOLLOWED.

- AT LEAST TWO FULL BAYS OF THE SKY-WEB II SYSTEM SHOULD BE INSTALLED AT ALL TIMES.
- IN SOME CASES, IT MAY ONLY BE POSSIBLE TO INSTALL THE MESH ON ONLY ONE SLOPE OF A DOUBLE SLOPE ROOF. IF THE MESH IS ALSO INSTALLED DOWN THE OTHER SLOPE A CERTAIN DISTANCE, THIS DISTANCE MUST BE EQUAL TO THE WIDTH OF THE MESH. FOR EXAMPLE, IF THE MESH IS INSTALLED FROM EAVE TO ROUGE ON ONE SLOPE AND 30 FEET PAST THE ROUGE ON THE OTHER SLOPE.
- WHEN THE MESH IS STRUNG OUT IN A BUNDLE ACROSS THE BUILDING WIDTH IT WILL APPEAR LONGER THAN NECESSARY. WHEN THE MESH IS STRETCHED OUT ACROSS THE BAY THE APPARENT EXTRA LENGTH WILL DISAPPEAR. DO NOT CUT THE LENGTH OF THE MESH UNTIL IT IS COMPLETELY INSTALLED.

WARNING

Workers must use additional fall protection while installing the SKY-WEB II SYSTEM.



For Details of Fabrication

THIS PRINT SUBJECT TO CHANGE WITHOUT NOTICE. FOR BUILDING ERECTOR ALWAYS USE THE PRINTS RECEIVED WITH THE BUILDING SHIPMENT.

ALL BUILDINGS SKY-WEB II™ INSTALLATION ON BLDG. STRUCT. REC.

DATE: 01-01-91
DRAWN BY: B
CHECKED BY: B
SCALE: 1:1

PROJECT NO: 01-019-01 B 1081342 00

WARNING

The SKY-WEB IISM SYSTEM must be installed exactly as shown on erection drawings. Improper installation could result in serious injury or death.

WARNING

The SKY-WEB II SYSTEM does not provide fall protection from heights greater than the plane of the roof.

WARNING

Workers must use additional fall protection while installing the SKY-WEB II SYSTEM.

CAUTION

Care must be used when pulling the SKY-WEB II SYSTEM over structurals to avoid snags, tears, or other damage.

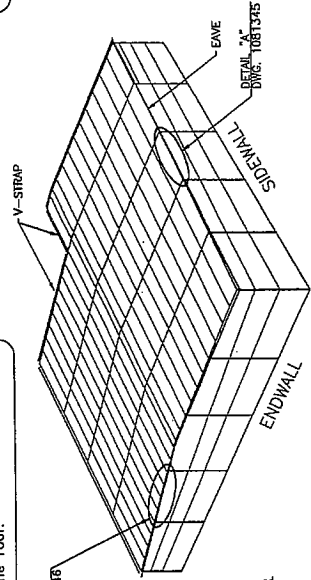
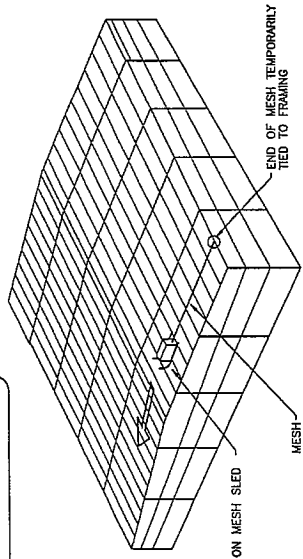

NOTE:
KEEP THE MESH COVERED AND PROTECTED FROM SUN AND WEATHER UNTIL TIME TO INSTALL IT. EXPOSURE TO CYCLES OF RAIN AND SUN MAY CAUSE THE KNOTS TO DRAW UP TIGHTER, THIS MAY CAUSE THE SIZE OF THE MESH TO SHRINK MAKING THE MESH HARDER TO INSTALL CORRECTLY.

NOTE:
THE MESH MAY BE INSTALLED ALONG THE BUILDING RIGHT-TO-LEFT OR LEFT-TO-RIGHT. THE EDGES OF THE MESH FOR INTERIOR BAYS ARE THE SAME AND MAY BE PLACED ON EITHER SIDE OF THE BAY. THE EDGES OF THE MESH FOR THE END BAYS ARE NOT THE SAME. THE EDGES OF THE MESH FOR THE END BAYS MUST BE PLACED ON THE OUTSIDE EDGE OF THE END BAY.

STEP 1 LOCATE THE MESH AND PARTS

- EACH PACKAGE WILL BE MARKED "X" OF TOTAL NUMBER* (FOR EXAMPLE, "1" OF 37).
- MAKE SURE ALL PACKAGES ARE ON HAND.
- A COMPLETE INVENTORY OF ALL MESH AND SMALL PARTS SHOULD BE TAKEN IMMEDIATELY. MISSING PARTS MAY SHUT DOWN INSTALLATION.
- THE MESH WILL ARRIVE AT THE JOB SITE IN REINFORCED PLASTIC BAGS OR IN CARDBOARD BOXES. TAG ATTACHED ON ONE END OF THE MESH TO IDENTIFY ON WHICH BAY(S) IT SHOULD BE INSTALLED.
- THE MESH FOR END BAYS WILL HAVE AN ORANGE TAG. THE MESH FOR INTERIOR BAYS WILL HAVE A WHITE TAG.
- ARRIVE AT THE JOB SITE IN A CARDBOARD BOX.
- INSTALLATION INSTRUCTIONS ARE LOCATED IN THE CARDBOARD BOX. READ AND UNDERSTAND ALL INSTRUCTIONS BEFORE STARTING INSTALLATION.

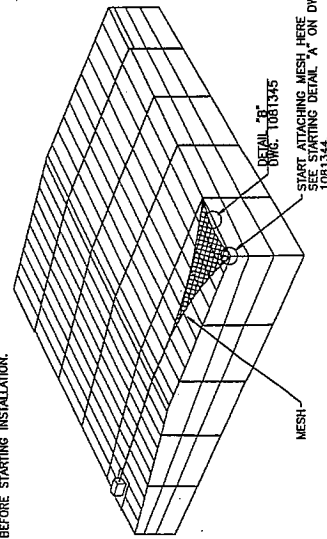

STEP 4 ATTACH MESH TO V-STRAPS

- AT THE FAR EAVE, LEAVE THE MESH ON THE SLED OR PLACE IT ON A TEMPORARY PLYWOOD PLATFORM. DO NOT HANG MESH OVER THE EAVE.
- STARTING AT THE EAVE, STRETCH THE MESH ACROSS THE WIDTH OF THE BAY.
- STARTING AT THE CORNER, WHERE THE INSTALLATION OF THE V-STRAPS WAS STARTED, LOOP THE MESH INTO THE WIRE CLIPS AT THE CORNER (SEE DETAIL "A" DWG. 1081344).
- AND ALONG THE SIDEWALL (SEE DETAIL "B" DWG. 1081345).
- NEXT LOOP THE MESH INTO THE WIRE CLIPS ALONG THE ENDWALL (SEE DETAIL "C" DWG. 1081346).
- WHEN PROPERLY INSTALLED THERE MAY STILL BE EXTRA LENGTH OF MESH AT THE EAVE. THIS IS NORMAL.

STEP 2 ATTACH V-STRAPS AND WIRE CLIPS

- START INSTALLING THE V-STRAPS AT A CORNER. THIS SHOULD BE THE SAME CORNER WHERE THE INSTALLATION OF THE MESH WILL BE STARTED. (SEE DETAIL "A" DWG. 1081344)
- INSTALL V-STRAPS TO THE FRAMING ON THE ENDWALL (SEE DETAIL "A" DWG. 1081346 FOR ENDWALLS)
- EXCEPT AT THE CORNER, INSTALL THE WIRE CLIP IN THE SLOT OF BOTH V-STRAPS WHERE THE V-STRAPS OVERLAP.

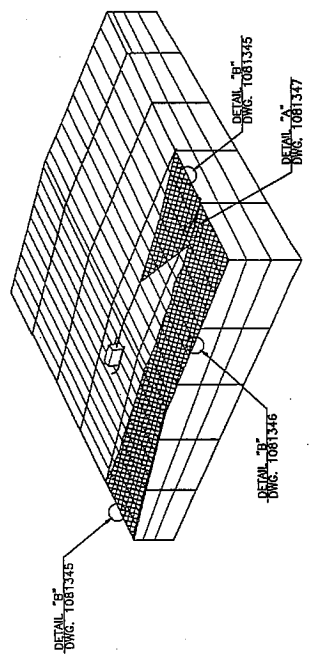

STEP 3 STRING MESH OVER FRAMING

- PULL THE MESH AT THE EDGE OF THE ROOF FRAMING.
- IF THE MESH IS TO COVER ONLY ONE BAY, THEN PLACE THE BAG IN THE CENTER OF THE BAY. IF THE MESH IS MADE TO COVER TWO BAYS, THEN PLACE THE BAG IN THE CENTER OF THE COMBINED BAYS.
- DO NOT OPEN THE GREEN TWINE CUT OPEN THE BAG AT THE TAG END. PULL ON THE SMALL ROPE THAT IS ATTACHED TO GREEN TWINE AND FEED OUT A SHORT LENGTH OF MESH. DO NOT CUT THE SMALL ROPE.
- TEMPORARILY PRESS THE ROOF FRAMING ALLOWING THE MESH TO STRING OUT OF THE BAG. ONLY STRING OUT A WORKABLE LENGTH OF MESH, APPROXIMATELY 100 TO 150 FEET. THE PATENTED SKY-WEB II MESH SLED IS OPTIONAL AND RECOMMEND FOR STRINGING BAG ACROSS THE EAVE AND CORNER. THE BAG SHOULD BE SHIPPED WITH THE MESH SLED.
- ON SMALL BUILDINGS, THE MESH MAY BE STRING OVER THE FRAMING BY PULLING THE TAG END OF THE MESH ACROSS THE FRAMING. THE BAG LEFT ON THE GROUND, FOR SHORT BUILDINGS, AS THE MESH IS STRING OUT.

STEP 5 CONTINUE INSTALLATION ON OTHER BAYS

- REPEAT STEP 3, EXCEPT AS NOTED BELOW.
- LOOP THE MESH INTO THE WIRE CLIPS ALONG THE EAVE FIRST. (SEE DETAILS "B" & "C" DWG. 1081345)
- STARTING AT THE EAVE, STRETCH THE PIECES OF MESH TOGETHER (SEE DETAIL "A" DWG. 1081347).

STEP 6 INSTALLING MESH ON THE LAST BAY

- ON THE LAST BAY, ATTACH THE MESH ALONG THE ENDWALL FIRST.
- THEN START ATTACHING THE MESH ALONG THE SIDEWALLS STARTING AT THE OUTSIDE CORNER AND WORKING TOWARD THE INTERIOR BAYS.

STEP 7 (OPTIONAL)

- AFTER ALL MESH IS COMPLETELY INSTALLED, ANY EXTRA LENGTH OF MESH AT THE SIDEWALLS MAY BE CUT OFF.

THIS PRINT SUBJECT TO CHANGE WITHOUT NOTICE FOR BUILDING ERECTION ALWAYS USE THE PRINTS RECORDED WITH THE BUILDING SHIPMENT.

ALL BUILDINGS

SKY-WEB IISM INSTALLATION SEQUENCE

DATE: 12/22/94

REVISION NUMBER: B 1081343 02

DATE: 01-19-01

REVISION NUMBER: B 1081343 02

AWC Engineering Corporation

- STEPS:
1. BEGIN INSTALLATION OF THE V-STRAPS AT A CORNER BETWEEN THE ENDWALL AND SIDEWALL AS SHOWN.
 2. INSTALL A WIRE CLIP IN THE V-STRAP ALONG THE ENDWALL.
 3. LOOP THE 3RD "DIAMOND" INTO THIS WIRE CLIP (ALONG THE ENDWALL).
 4. LOOP THE 5TH "DIAMOND" INTO THE NEXT WIRE CLIP ALONG THE ENDWALL.
 5. FROM THE WIRE CLIP IN THE CORNER COUNT OVER TWO KNOTS. AT THIS LOCATION GATHER THREE KNOTS AND LOOP THEM INTO THE WIRE CLIP (ALONG THE SIDEWALL).
 6. COUNTING ALONG THE SAME LINE OF KNOTS, COUNT OVER TWO KNOTS AND GATHER INTO WIRE CLIP (ALONG THE SIDEWALL).
 7. CONTINUE ALONG THE SIDEWALL EAVE MEMBER. SEE SIDEWALL DETAILS ON DWG. 1081345.

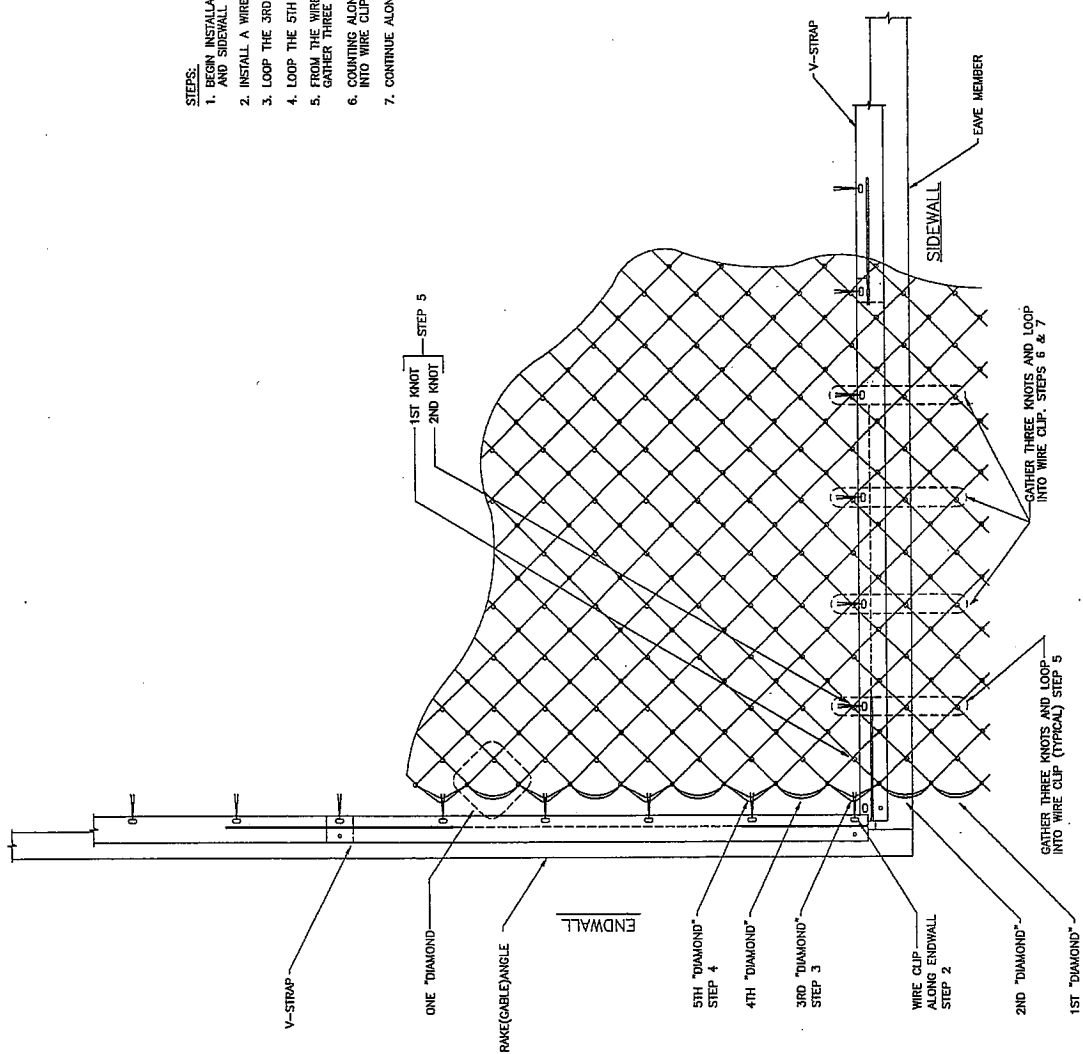

	THIS PRINT SUBJECT TO CHANGE WITHOUT NOTICE. FOR BUILDING ERECTOR ALWAYS USE THE PRINTS RECEIVED WITH THE BUILDING SHIPMENT.	SKY-WEB II™ MESH ATTACHMENT STARTING DETAIL	ALL BUILDINGS
	DATE: 09/29/99 DRAWN BY: C-019-01	REV: B 1081344 00	B 1081344 00

01-019-01 B 1081344 00

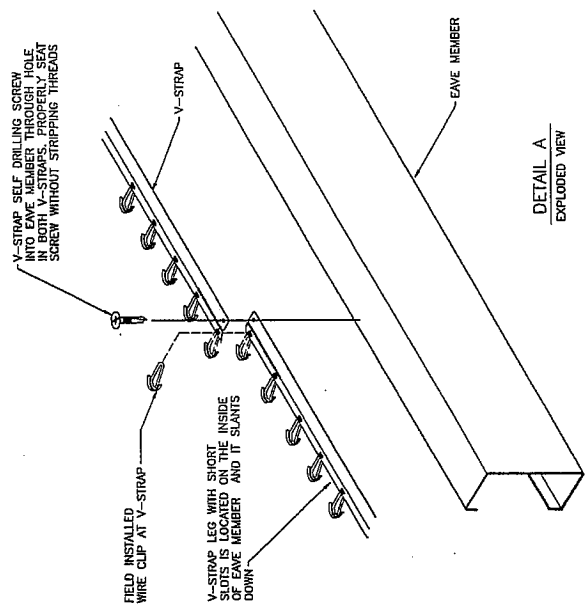

DETAIL A
EXPLODED VIEW

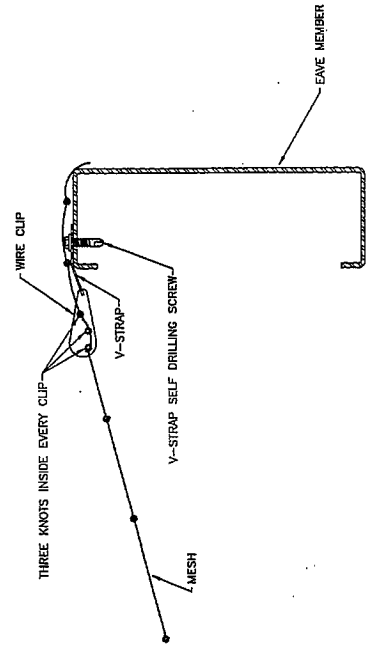

SECTION B-B
TYPICAL AT SIDEWALL

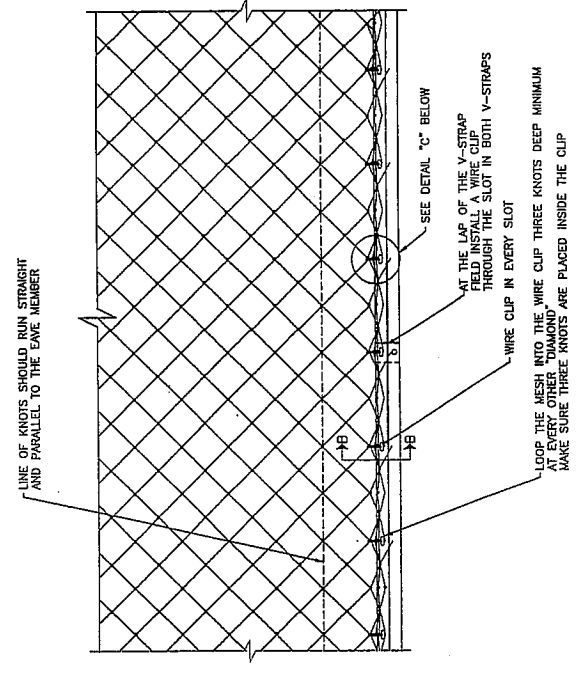

TYPICAL PLAN VIEW AT SIDEWALL

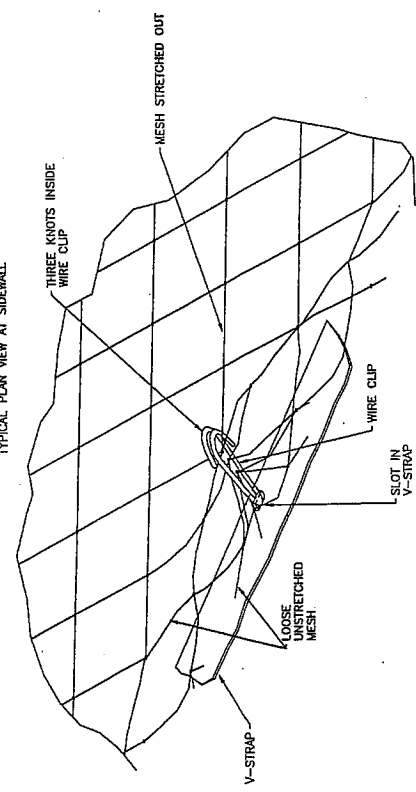

DETAIL C
WIRE CLIP AT SIDEWALL

THIS PRINT SUBJECT TO CHANGE WITHOUT NOTICE. FOR BUILDING ERECTION ALWAYS USE THE PRINTS RECEIVED WITH THE BUILDING SHIPMENT.

ASQC Certified for Design & Fabrication

DATE: 09/28/98
DRAWING NUMBER: B 1081345-01
REV: 01-01E-01

ALL BUILDINGS SIDEWALL DETAILS SKY-HEB II™ B 1081345 00

01-019-01 B 1081345 00

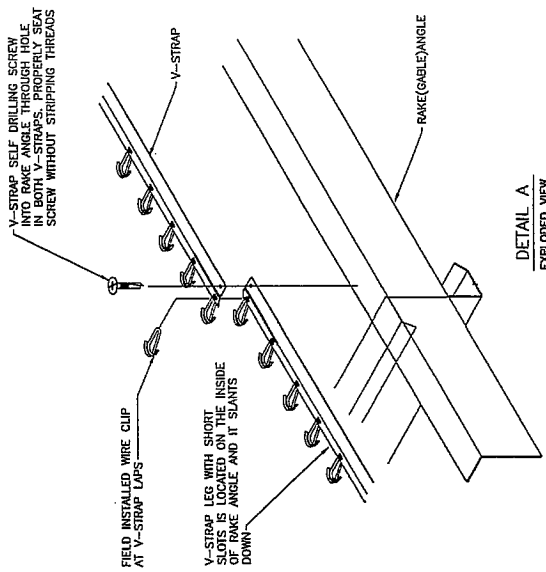

NOTE:
IF THE BUILDING HAS AN MR-24 ROOF, INSTALL TRIM CLIPS TO GABLE ANGLE BEFORE INSTALLING V-STRAPS. V-STRAPS MAY RUN OVER TRIM CLIP PASTEREL.

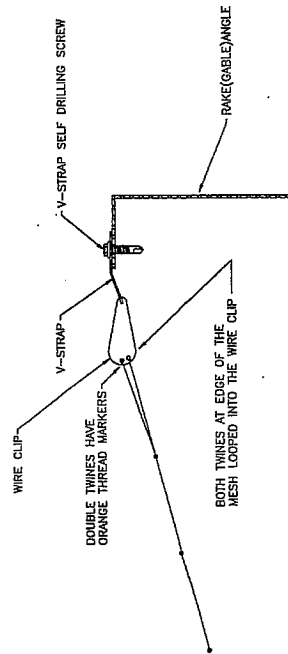

SECTION A-A
TYPICAL AT ENDWALL

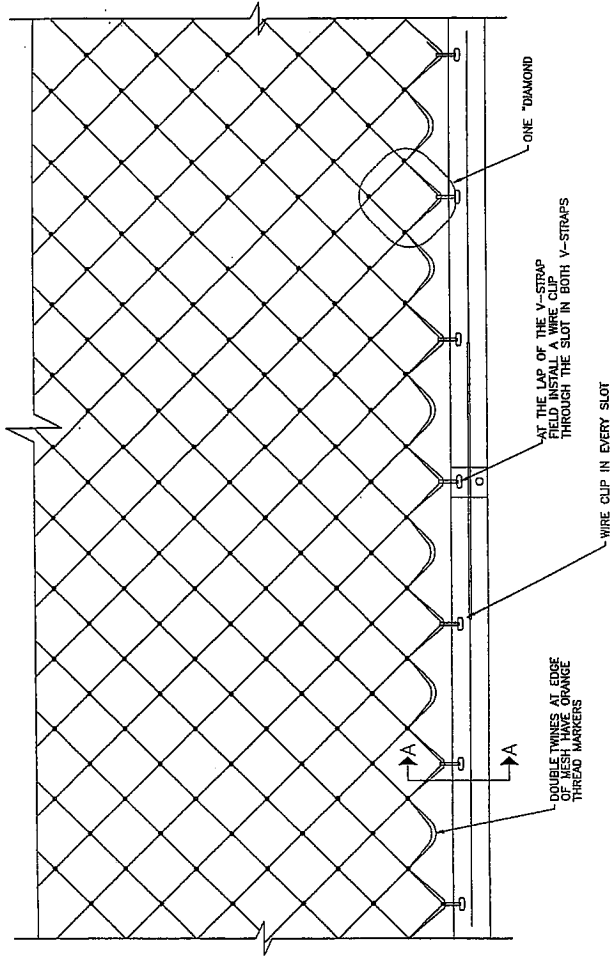

DETAIL B
TYPICAL PLAN VIEW AT ENDWALL

- STEPS:
1. VERIFY THAT THE TWINES AT THE EDGE OF THE MESH TO BE INSTALLED AT THE ENDWALL HAVE ORANGE THREAD MARKERS.
 2. LOOP THE MESH INTO THE WIRE CLIP AT EVERY OTHER "DIAMOND"
 3. MAKE SURE BOTH TWINES AT THE EDGE ARE LOOPED INTO THE WIRE CLIP.
 4. SEE DETAIL A FOR AN EXPLODED VIEW OF THE V-STRAP CONNECTION.



THIS PRINT SUBJECT TO CHANGE WITHOUT NOTICE.
FOR BUILDING ERECTION ALWAYS USE THE PRINTS
RECEIVED WITH THE BUILDING SHIPMENT.

ALL BUILDINGS
ENDWALL DETAILS
DATE: 07/28/98
DRAWN BY: B 1081346 00
REV: 01-019-01

GROUP: 01-019-01
DRAWING NUMBER: B 1081346 00
REV: 01-019-01

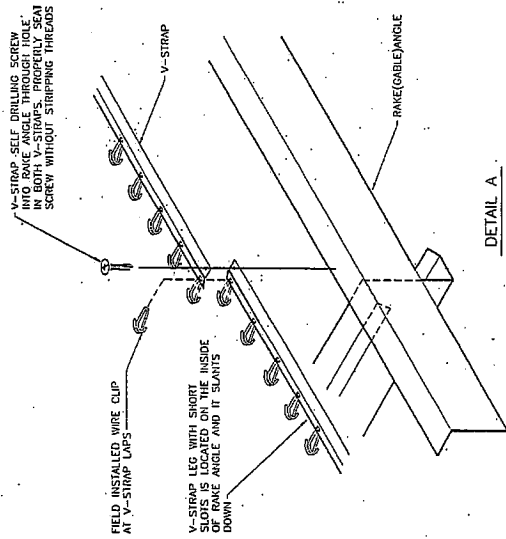

NOTE: THE BUILDING HAS AN IR-24 ROOF. INSTALL TRIM CLIPS TO FIELD AND RAKE ANGLE. V-STRAPS-V-STRAPS MAY RUN OVER TRIM CLIP FASTENER.

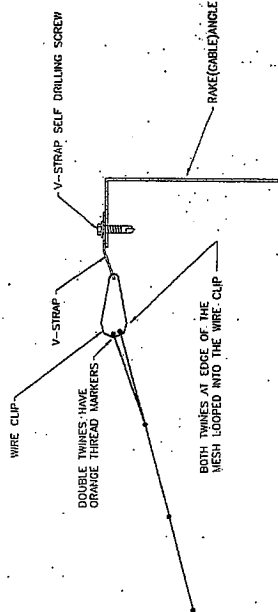

SECTION A-A
TYPICAL AT ENDWALL

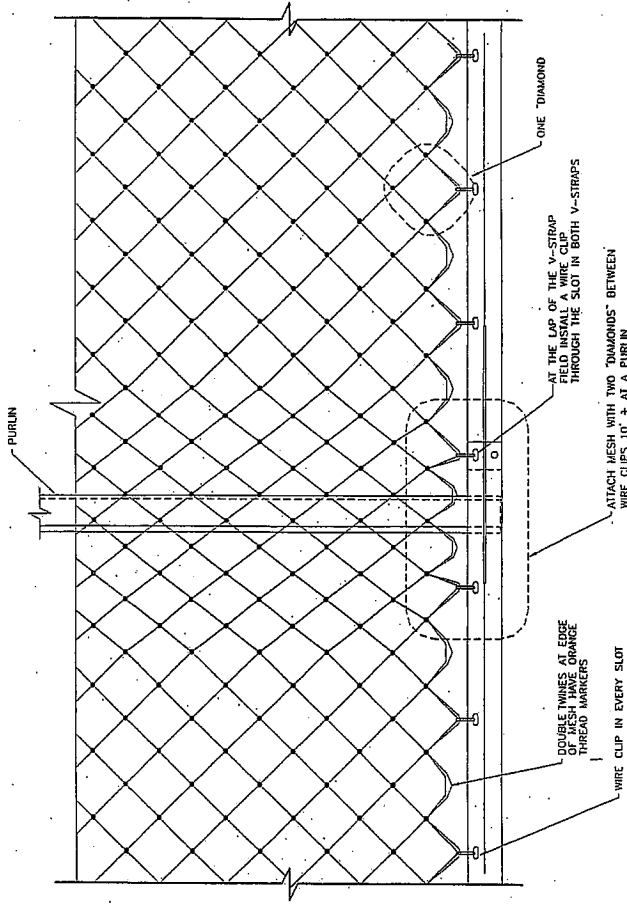

DETAIL B
TYPICAL PLAN VIEW AT ENDWALL

- STEPS:
1. VERIFY THAT THE TWINES AT THE EDGE OF THE MESH TO BE INSTALLED AT THE ENDWALL, HAVE ORANGE THREAD MARKERS.
 2. LOOP THE MESH INTO THE WIRE CLIP AT EVERY OTHER "DIAMOND" EXCEPT AS SHOWN IN DETAIL B.
 3. MAKE SURE BOTH TWINES AT THE EDGE ARE LOOPED INTO THE WIRE CLIP.
 4. SEE DETAIL A FOR AN EXPLODED VIEW OF THE V-STRAP CONNECTION.

NOTE: USE THIS DRAWING ONLY IF INSULATION IS THICKER THAN 8"
(USE DRAWING 1081346 IF INSULATION IS 8" THICK OR LESS)

DATE	07/17/05	DESIGN	CRP	585
FIRST RELEASE				

THIS PRINT SUBJECT TO CHANGE WITHOUT NOTICE. FOR BUILDING ERECTION ALWAYS USE THE PRINTS RECEIVED WITH THE BUILDING SHIPMENT.

for Detail & Fabrication

DATE: 07/17/05
DRAWING NUMBER: 01-019-01 B 1081000 00
REV: 01-019-01 B 1081000 00

ENDWALL DETAILS

SKY-WEB II

ALL BUILDINGS

WARNING

The SKY-WEB IISM SYSTEM must be installed exactly as shown on erection drawings. Improper installation could result in serious injury or death.

WARNING

The SKY-WEB II SYSTEM does not provide fall protection from heights greater than the plane of the roof.

WARNING

Workers must use additional fall protection while installing the SKY-WEB II SYSTEM.



CAUTION

Care must be used when pulling the SKY-WEB II SYSTEM over structurals to avoid snags, tears, or other damage.

STEPS:

1. AT THE EAVE, LOOP THE END OF THE SPLICE CORD THROUGH BOTH PIECES OF MESH AND TIE IT SECURELY. MAKE SURE THE KNOT IS STRONG ENOUGH TO NOT COME UNTIED.
2. LACE THE "MESH NEEDLE" BACK AND FORTH BETWEEN THE EDGES OF BOTH PIECES OF MESH. LOOP THROUGH EACH "DIAMOND" ALONG BOTH EDGES.
3. PULL THE SPLICE CORD LIGHTLY TO ALLOW ENOUGH SLACK IN THE SPLICE CORD TO FORM A ZIGZAG PATTERN THAT MATCHES THE PATTERN OF THE MESH.
4. TIE THE SPLICE CORD TO THE MESH AT EACH PURLIN (APPROXIMATELY 5' ON CENTER). THIS WILL KEEP THE SPLICE FROM "UNZIPPING" IF THE MESH NEEDLE IS DROPPED, OR IF THE SPLICE CORD IS ACCIDENTLY CUT AFTER INSTALLATION.
5. WHEN THE MESH NEEDLE IS ABOUT TO RUN OUT OF SPLICE CORD, TIE THE SPLICE CORD TO THE MESH ABOUT 2' TO 3' FROM THE END. TIE THE END TO THE SPLICE CORD OF A NEW MESH NEEDLE AND CONTINUE LACING.
6. AT THE FAR EAVE, TIE OFF THE SPLICE CORD TO BOTH PIECES OF MESH (SAME AS NOTE 1).

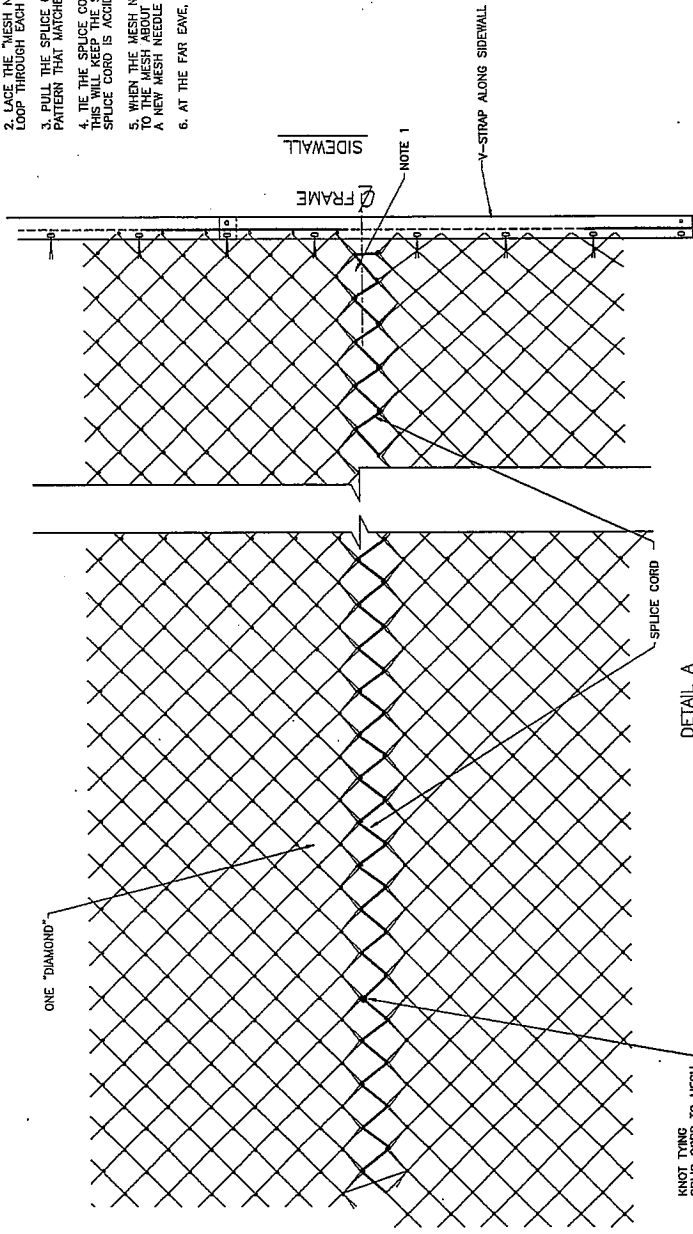

THIS PRINT SUBJECT TO CHANGE WITHOUT NOTICE FOR BUILDING DEPARTMENT ALWAYS USE THE PRINTS PROVIDED WITH THE BUILDING PERMIT.

ALL BUILDINGS	MESH TO MESH SPLICE DETAILS
DATE: 07/21/09	ISSUED: 07/21/09
PROJECT: 01-019-01	REVISION: B 1081347 02

01-019-01 B 1081347 02

for Details & Information

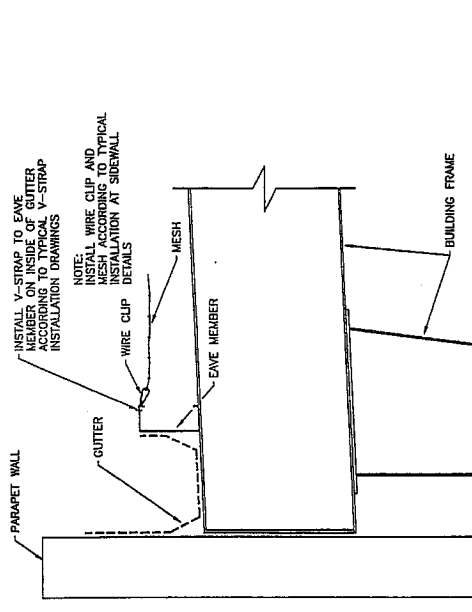

TYPICAL SIDEWALL WITH PARAPET AND GUTTER
COLD FORMED PURLIN ROOF FRAMING

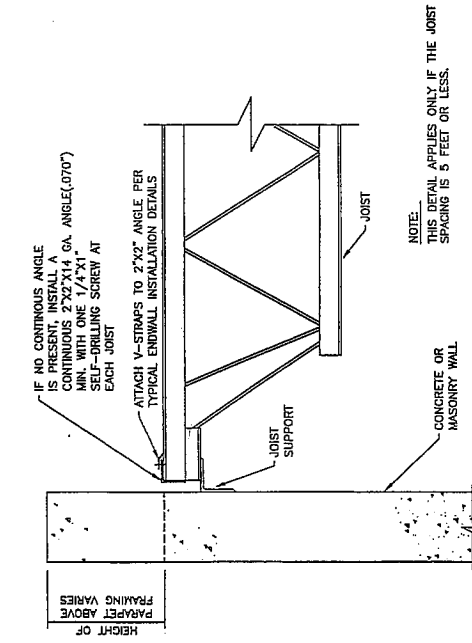

TYPICAL DETAIL AT CONCRETE OR MASONRY ENDWALL
JOIST ROOF FRAMING

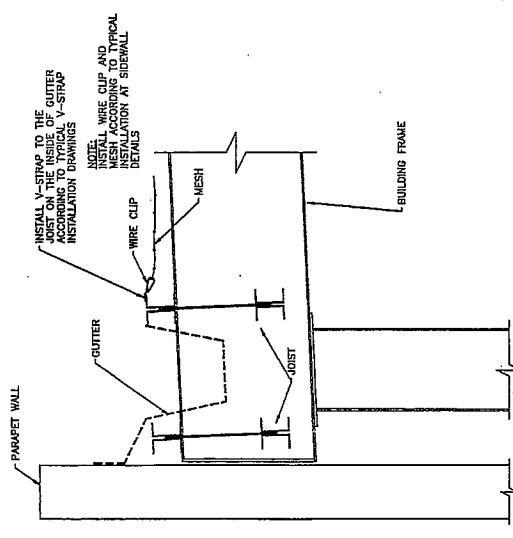

TYPICAL SIDEWALL WITH PARAPET AND GUTTER
JOIST ROOF FRAMING

THIS PRINT SUBJECT TO CHANGE WITHOUT NOTICE FOR BUILDING ERECTION ALWAYS USE THE PRINTS RECEIVED WITH THE BUILDING PERMIT.

for Design & Fabrication

DATE: 02/26/88
DRAWN BY: B-1018-01
REVISION NUMBER: B 1081348 00

SKY-WEB, INC.
DETAILS AT PARAPET WALLS
ALL BUILDINGS

DATE: 01-019-01
DRAWING NUMBER: B 1081348 00
REVISION NUMBER: B 1081348 00